

A United Volleyball Supply, LLC. Company • 14615 NE 91st ST, Bldg B, REDMOND, WA 98052 • 1996-2007© VOLLEYBALLUSA.COM
PH: 1-800-494-3933 • FAX: 425-827-2230

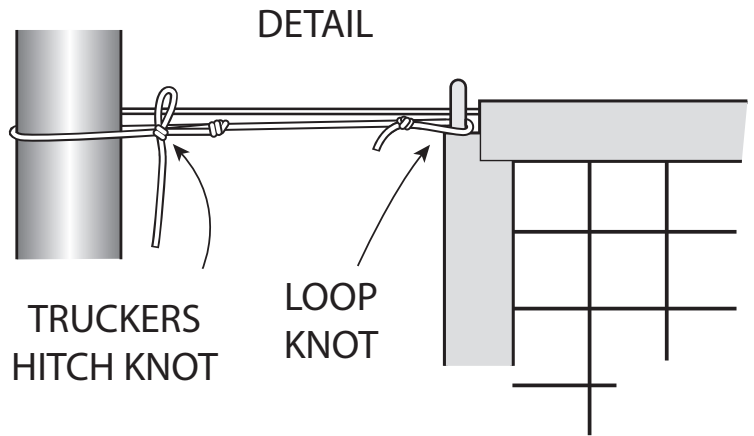

HOW TO TIE A LOOP KNOT AROUND DOWEL

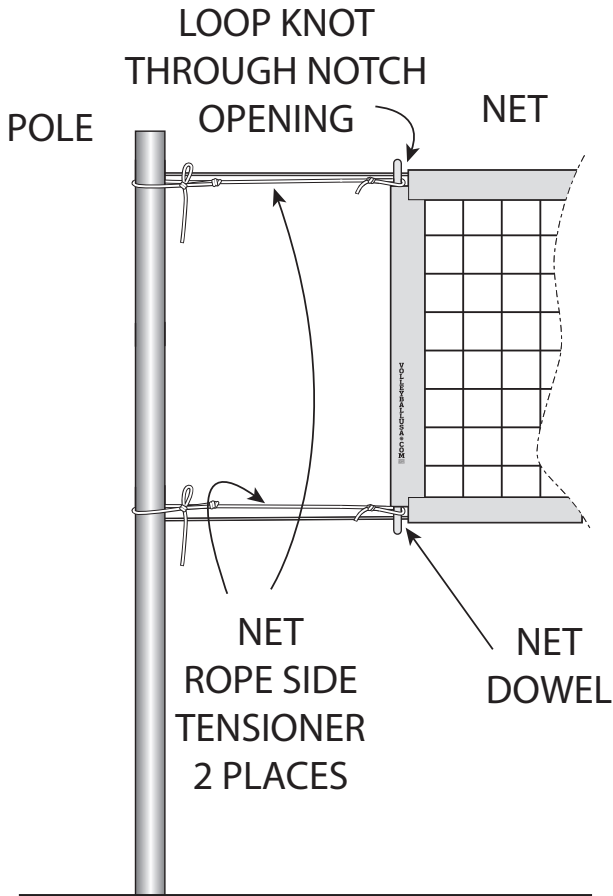
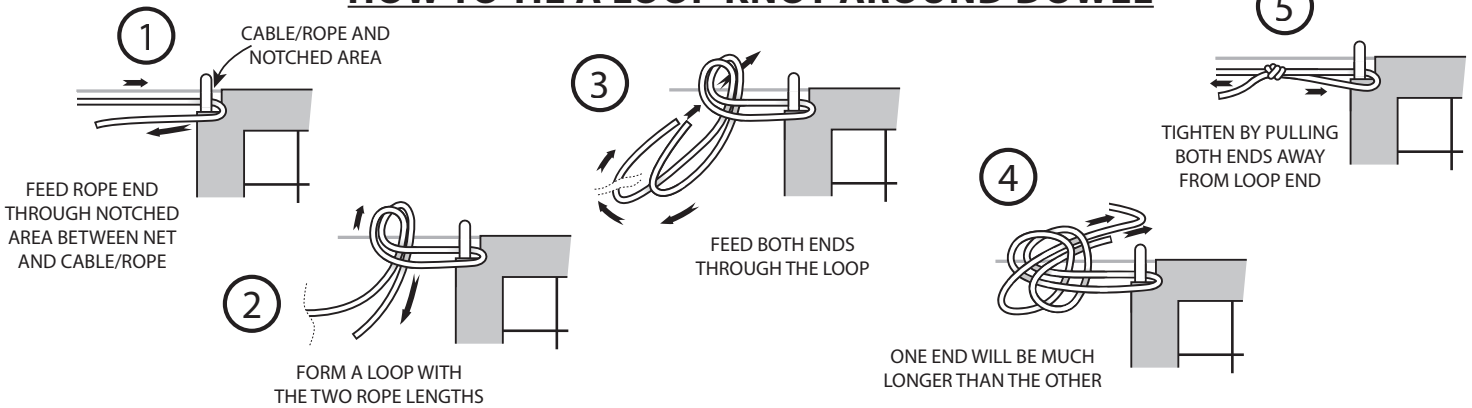

HOW TO TIE A LOOP KNOT

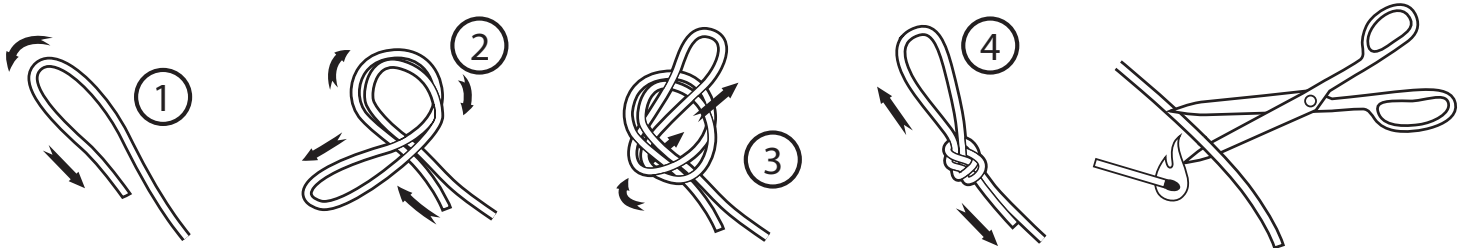

CUT UNDESIRED LENGTHS (OPTIONAL). FLAME TREAT ENDS OR CUTTING AREA WITH MATCH OR LIGHTER TO KEEP CORD FROM FRAYING. USE CAUTION WHEN WORKING WITH FIRE.

A United Volleyball Supply, LLC. Company • 14615 NE 91st ST, Bldg B, REDMOND, WA 98052 • 1996-2007© VOLLEYBALLUSA.COM
 PH: 1-800-494-3933 • FAX: 425-827-2230

HOW TO TIE A TRUCKERS HITCH KNOT

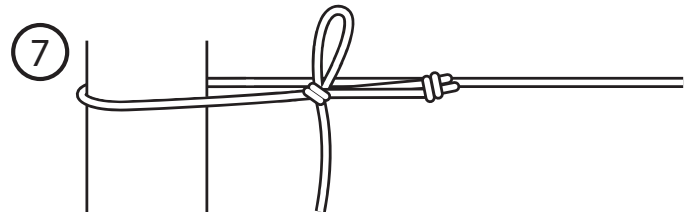
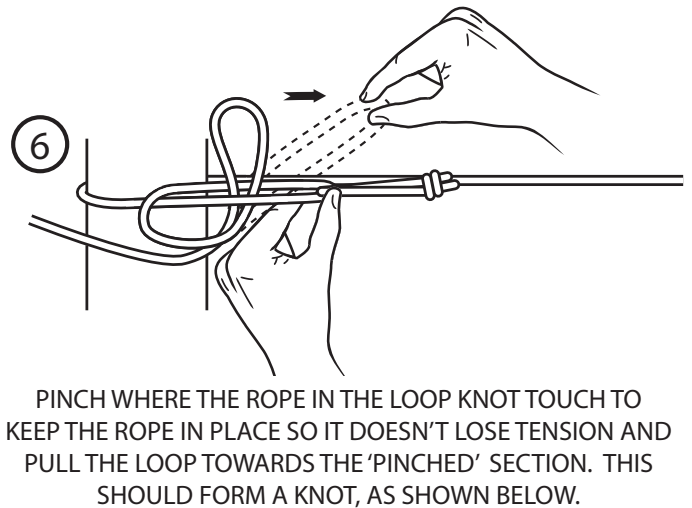
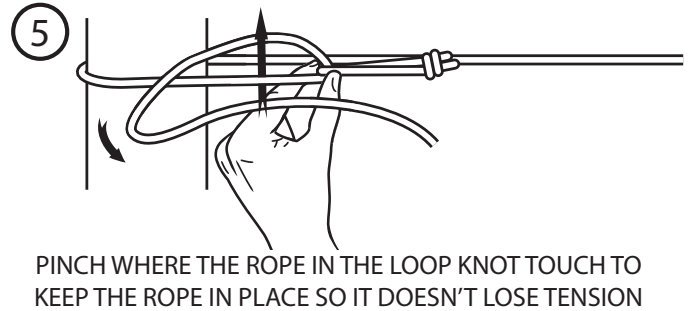
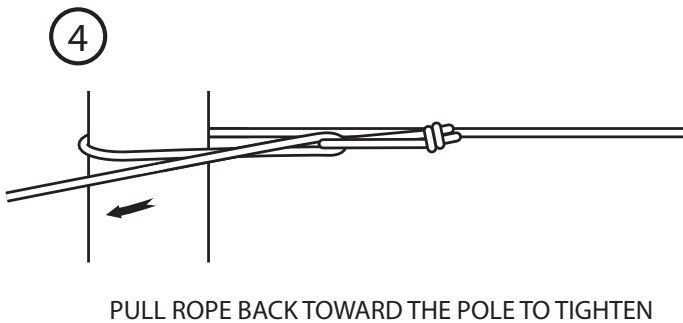
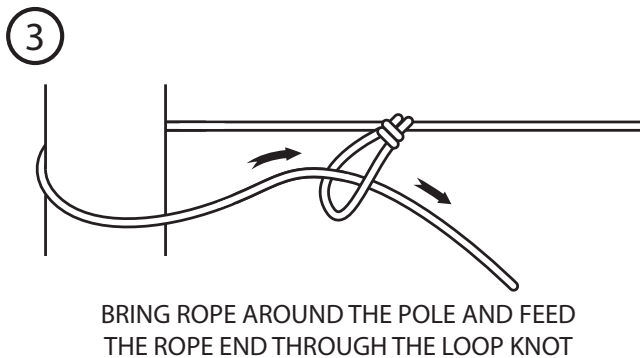
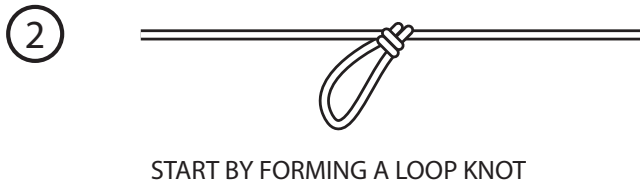

CABLE CLAMPS - CLAMPING A WIRE LOOP

SMALL CABLE CLAMP



LARGE CABLE CLAMP



HORSESHOE BOLT



CABLE CLAMP



NUTS

CLAMPED CABLE WIRE LOOP

